

RoHS **TMOV34S® Varistor Series**



Description

The Littelfuse TMOV34S® thermally protected varistor series consists of a 34mm square format varistor element (MOV) with an integral thermally activated element. This element is designed to open in the event of overheating due to abnormal overvoltage, limited current conditions. Certain TMOV34S® devices are offered with a "monitor" lead which may be connected to signalling circuitry to indicate if the MOV has been disconnected from the circuit. TMOV34S® Series devices offer quick thermal response due to the close proximity of the integrated thermal element to the MOV body. The integrated configuration also offers lower inductance than most discrete solutions resulting in improved clamping performance to fast over voltage transients.

Agency Approvals

Agency	Agency File Number	Status
	UL1449 3rd Edition	Pending*
	IEC-CECC Spec: QC42201-C001, QC42201-A001, IEC 60950-1 (Annex Q)	E1274/F

* UL1449 3rd Edition approval of TMOV34S series is currently pending related to the integrated thermal element of this series. See Notes section under Device Ratings and Specifications table on next page. Contact your Littelfuse product representative to discuss alternatives and for additional information.

Features

- US patent for thermally protected MOV— Patent # 6636403
- High peak current rating to 40 kA
- -55°C to +85°C operating temp
- RoHS Compliant and Lead-free Available
- Alternative design available with narrow 3mm wide monitor (right) lead
- Alternative design available with 2 leads only (no monitor lead)

Applications

- SPD (TVSS) Products
- AC Panel Protection Modules
- AC Line Power Supplies
- AC Power Meters
- UPS (Uninterruptable Power Supply)
- Inverters
- AC/DC Power Supplies
- DIN Rail

TMOV34S® Series

Absolute Maximum Ratings

• For ratings of individual members of a series, see Device Ratings and Specifications chart

Continuous	TMOV34S Series	Units
Steady State Applied Voltage:		
AC Voltage Range ($V_{MIACRMS}$)	115 to 750	V
Transients:		
Peak Pulse Current (I_{TM})		
For 8/20 μ s Current Wave, single pulse	up to 40,000	A
Single Pulse Energy Range		
For 2ms Current Wave	235 to 1050	J
Operating Ambient Temperature Range (T_A)	-55 to + 85	°C
Storage Temperature Range (T_{STG})	-55 to + 125	°C
Temperature Coefficient (α^V) of Clamping Voltage (V_C) at Specified Test Current	<0.01	%/°C
Hi-Pot Encapsulation (Isolation Voltage Capability)	2500	V
Thermal Protection Isolation Voltage Capability (when operated) *See notes below table for more information	600*	V
Hi-Pot Encapsulation (COATING Isolation Voltage Capability)		V
COATING Insulation Resistance	1000	M Ω

* UL1449 3rd Edition approval of TMOV34S series is currently pending due to matters related to testing of the the integrated thermal element of this series. Contact your Littelfuse product representative to discuss alternatives and for additional information. Devices with ratings >420V have not been evaluated.

CAUTION: Stresses above those listed in "Absolute Maximum Ratings" may cause permanent damage to the device. This is a stress only rating and operation of the device at these or any other conditions above those indicated in the operational sections of this specification is not implied.

TMOV34S® Series Ratings & Specifications - Standard 3 Lead Design

Lead-free and RoHS Compliant Models	Standard Models	Maximum Rating (85°C)					Specifications (25°C)			
		Continuous		Transient			Varistor Voltage at 1mA Test Current	Maximum Clamping Volt V_c at 200A Current (8/20 μ s)	Typical Capacitance $f = 1$ MHz	
		AC Volts	DC Volts	MCOV Surge Arrester	Energy 2ms	Peak Current 8 x 20 μ s				
Part Number	Part Number	$V_{MIACIRMS}$ (V)	V_{MIACI}	$V_{MIACIRMS}$ (V)	W_{TM} 1 x Pulse (J)	I_{TM} 1 x Pulse (A)	V_{NIDC} Min (V)	V_{NIDC} Max (V)	V_c (V)	C (pF)
TMOV34S111MP	TMOV34S111M	115	150	98	235	40000 ¹	163	202	305	11500
TMOV34S131MP	TMOV34S131M	130	175	111	270	40000 ²	184	228	345	10000
TMOV34S141MP	TMOV34S141M	140	188	119	291	40000 ³	198	248	375	9000
TMOV34S151MP	TMOV34S151M	150	200	128	300	40000 ⁴	212	268	405	8000
TMOV34S181MP	TMOV34S181M	180	240	153	330	40000 ⁵	254	312	488	6800
TMOV34S201MP	TMOV34S201M	200	265	170	335	40000	283	357	540	6500
TMOV34S251MP	TMOV34S251M	250	330	213	370	40000	354	429	650	5000
TMOV34S271MP	TMOV34S271M	275	369	234	400	40000	389	473	730	4500
TMOV34S301MP	TMOV34S301M	300	400	255	435	40000	433	528	780	4050
TMOV34S321MP	TMOV34S321M	320	420	272	460	40000	462	561	830	3800
TMOV34S331MP	TMOV34S331M	330	435	281	475	40000	476	581	855	3700
TMOV34S351MP	TMOV34S351M	350	460	298	500	40000	505	616	910	3500
TMOV34S391MP	TMOV34S391M	385	506	327	550	40000	555	678	1005	3300
TMOV34S421MP	TMOV34S421M	420	560	357	600	40000	610	748	1130	3000
TMOV34S461MP	TMOV34S461M	460	610	391	620	40000	642	783	1188	2800
TMOV34S481MP	TMOV34S481M	480	640	408	650	40000	670	825	1240	2700
TMOV34S511MP	TMOV34S511M	510	675	434	700	40000	735	910	1350	2500
TMOV34S551MP	TMOV34S551M	550	700	468	735	40000	770	939	1415	2250
TMOV34S571MP	TMOV34S571M	575	730	489	770	40000	805	1000	1480	2200
TMOV34S621MP	TMOV34S621M	620	800	527	840	40000	880	1074	1589	2100
TMOV34S661MP	TMOV34S661M	660	850	561	900	40000	940	1160	1720	2000
TMOV34S681MP	TMOV34S681M	680	890	578	950	40000	980	1195	1772	1970
TMOV34S751MP	TMOV34S751M	750	970	638	1050	40000	1080	1320	2000	1800

Notes :

Same ratings and specifications apply to 2 leaded alternative design. Replace 'M' with 'E' in part number. Refer to Part Numbering System at the end of this document..

1. Peak current applies to applications rated up to 100 VAC_{RMS}, 132 V_{DC}. Peak current is 30kA max for applications greater than 100 VAC_{RMS}, 132 V_{DC}.
2. Peak current applies to applications rated up to 115 VAC_{RMS}, 145 V_{DC}. Peak current is 30kA max for applications greater than 115 VAC_{RMS}, 145 V_{DC}.
3. Peak current applies to applications rated up to 123 VAC_{RMS}, 165 V_{DC}. Peak current is 30kA max for applications greater than 123 VAC_{RMS}, 165 V_{DC}.
4. Peak current applies to applications rated up to 132 VAC_{RMS}, 176 V_{DC}. Peak current is 30kA max for applications greater than 132 VAC_{RMS}, 176 V_{DC}.
5. Peak current applies to applications rated up to 158 VAC_{RMS}, 211 V_{DC}. Peak current is 30kA max for applications greater than 158 VAC_{RMS}, 211 V_{DC}.

TMOV34S® Series Ratings & Specifications - Alternative 2 Lead Design

Lead-free and RoHS Compliant Models	Maximum Rating (85°C)					Specifications (25°C)			
	Continuous		Transient			Varistor Voltage at 1mA Test Current	Maximum Clamping Volt V_C at 200A Current (8/20 μ s)	Typical Capacitance $f = 1$ MHz	
	AC Volts	DC Volts	MCOV Surge Arrester	Energy 2ms	Peak Current 8 x 20 μ s				
Part Number	$V_{M(AC)RMS}$ (V)	$V_{M(AC)}$	$V_{M(AC)RMS}$ (V)	W_{TM} 1 x Pulse (J)	I_{TM} 1 x Pulse (A)	$V_{N(DC)}$ Min (V)	$V_{N(DC)}$ Max (V)	V_C (V)	C (pF)
TMOV34S111EP	115	150	98	235	40000 ¹	163	202	305	11500
TMOV34S131EP	130	175	111	270	40000 ²	184	228	345	10000
TMOV34S141EP	140	188	119	291	40000 ³	198	248	375	9000
TMOV34S151EP	150	200	128	300	40000 ⁴	212	268	405	8000
TMOV34S181EP	180	240	153	330	40000 ⁵	254	312	488	6800
TMOV34S201EP	200	265	170	335	40000	283	357	540	6500
TMOV34S251EP	250	330	213	370	40000	354	429	650	5000
TMOV34S271EP	275	369	234	400	40000	389	473	730	4500
TMOV34S301EP	300	400	255	435	40000	433	528	780	4050
TMOV34S321EP	320	420	272	460	40000	462	561	830	3800
TMOV34S331EP	330	435	281	475	40000	476	581	855	3700
TMOV34S351EP	350	460	298	500	40000	505	616	910	3500
TMOV34S391EP	385	506	327	550	40000	555	678	1005	3300
TMOV34S421EP	420	560	357	600	40000	610	748	1130	3000
TMOV34S461EP	460	610	391	620	40000	642	783	1188	2800
TMOV34S481EP	480	640	408	650	40000	670	825	1240	2700
TMOV34S511EP	510	675	434	700	40000	735	910	1350	2500
TMOV34S551EP	550	700	468	735	40000	770	939	1415	2250
TMOV34S571EP	575	730	489	770	40000	805	1000	1480	2200
TMOV34S621EP	620	800	527	840	40000	880	1074	1589	2100
TMOV34S661EP	660	850	561	900	40000	940	1160	1720	2000
TMOV34S681EP	680	890	578	950	40000	980	1195	1772	1970
TMOV34S751EP	750	970	638	1050	40000	1080	1320	2000	1800

Notes :

Same ratings and specifications apply to 3 leaded design. Replace 'E' with 'M' in part number. Refer to Part Numbering System at the end of this document..

1. Peak current applies to applications rated up to 100 VAC_{RMS}, 132 V_{DC}. Peak current is 30kA max for applications greater than 100 VAC_{RMS}, 132 V_{DC}.
2. Peak current applies to applications rated up to 115 VAC_{RMS}, 145 V_{DC}. Peak current is 30kA max for applications greater than 115 VAC_{RMS}, 145 V_{DC}.
3. Peak current applies to applications rated up to 123 VAC_{RMS}, 165 V_{DC}. Peak current is 30kA max for applications greater than 123 VAC_{RMS}, 165 V_{DC}.
4. Peak current applies to applications rated up to 132 VAC_{RMS}, 176 V_{DC}. Peak current is 30kA max for applications greater than 132 VAC_{RMS}, 176 V_{DC}.
5. Peak current applies to applications rated up to 158 VAC_{RMS}, 211 V_{DC}. Peak current is 30kA max for applications greater than 158 VAC_{RMS}, 211 V_{DC}.

Typical time to open circuit under UL1449 Abnormal Overvoltage Limited Current Test

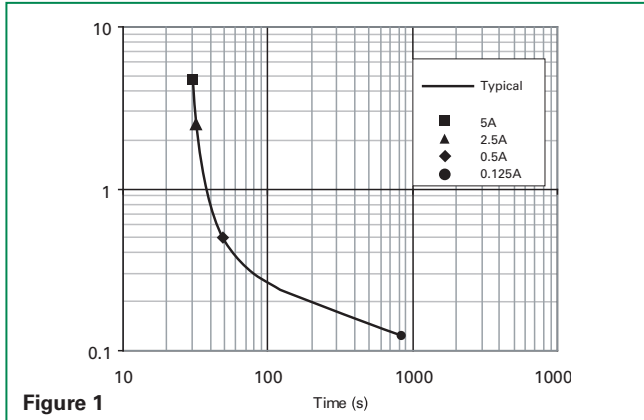

Figure 1

Note: The Industrial TMOV® Series TMOV34S® devices are intended, in conjunction with appropriate enclosure design, to help facilitate TVSS module compliance to UL 1449, Section 37.4 (Abnormal Overvoltage Limited Current Requirements). Under these extreme abnormal overvoltage conditions, the units will exhibit substantial heating and potential venting prior to opening. Modules should be designed to contain this possibility. Application testing is strongly recommended.

Peak Current & Energy Derating Curve

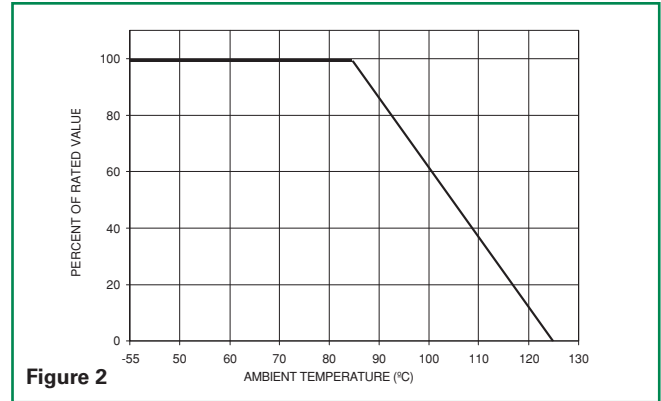

Figure 2

For applications exceeding 85°C ambient temperature, the peak surge current and energy ratings must be reduced as shown.

Pulse Rating Curve

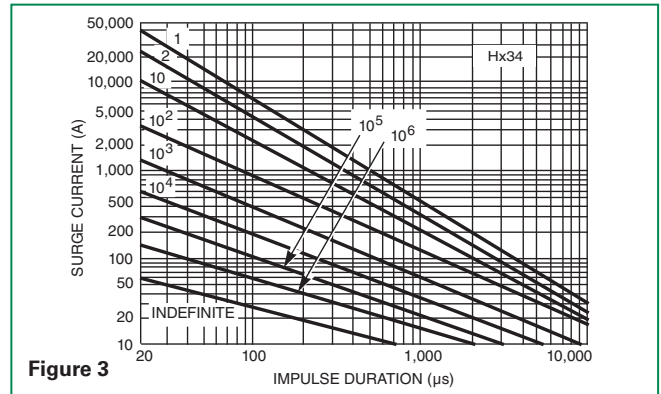

Figure 3

V-I Characteristic Curves for TMOV34S® Varistor

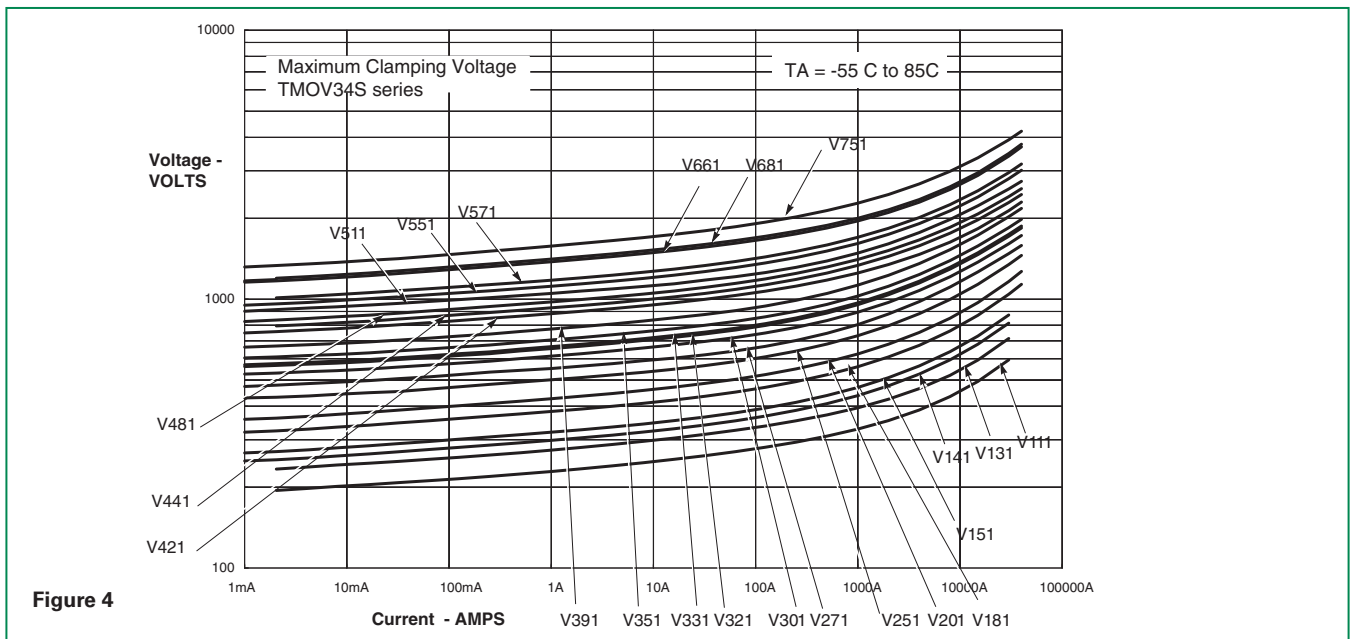
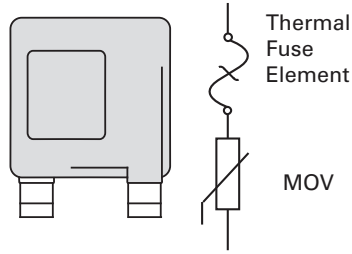

Figure 4

TMOV34S® Series

Lead Configurations

TMOV34S® "E" 2-Lead Varistor



TMOV34S® "M" 3-Lead Varistor

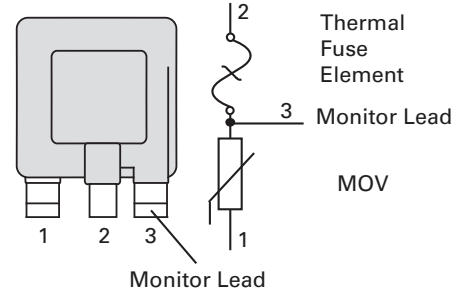

Note: MOVs are non-polarized passive elements

TMOV34S® Varistor Application Examples

The application examples below show how the monitor lead on the TMOV34S® can be used to indicate that the thermal element has been opened. This signifies that the circuit is no longer protected from transients by the MOV.

Application Example 1

In this case, the LED is normally on, and is off when the thermal element opens.

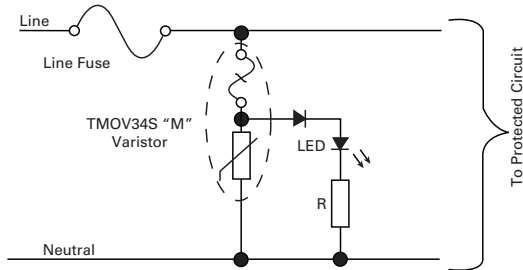

Application Example 2

This circuit utilizes an optocoupler to provide galvanic isolations between the TMOV34S® varistor and the indicating or alarm circuitry.

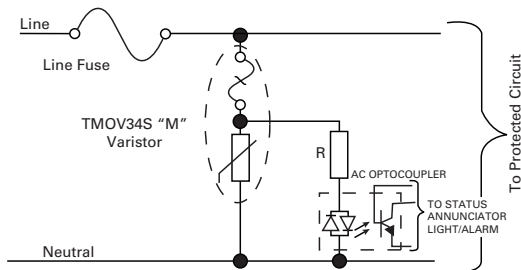

Application Example 3

This circuit illustrates the use of the monitoring lead of the TMOV34S® varistor to ensure that equipment is only operated when overvoltage protection is present. In normal operation the load switch relay solenoid is powered via the monitor lead of the TMOV34S® varistor. In the event of the thermal element being activated, the relay will de-activate, cutting power to the protected circuit and the fault LED will illuminate.

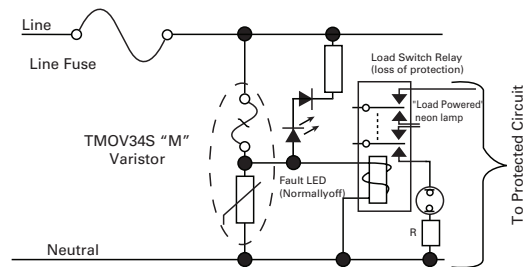

Please note: Indicator circuits are provided as a guideline only. Verification of actual indicator circuitry is the responsibility of the end user. Component values selected must be appropriate for the specific AC line voltage service and application.

Wave Solder Profile

Because the TMOV34S® Series varistors contain a thermal protection device, care must be taken when soldering the devices into place. Two soldering methods are possible. Firstly, hand soldering:

It is recommended to heat-sink the leads of the device. Secondly, wave-soldering: It is critically important that all preheat stage and the solder bath temperatures are rigidly controlled.

Non Lead-free Profile

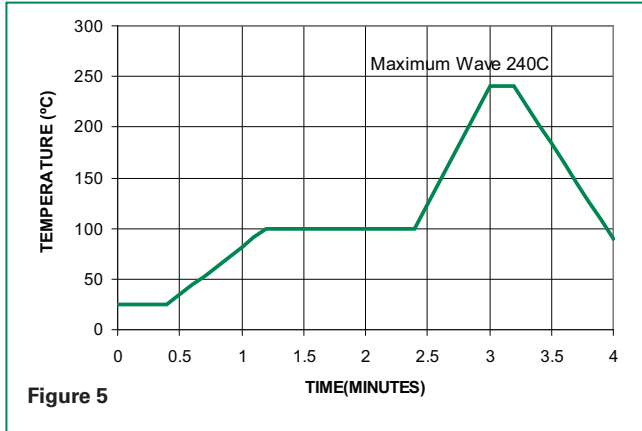

Lead-free Profile

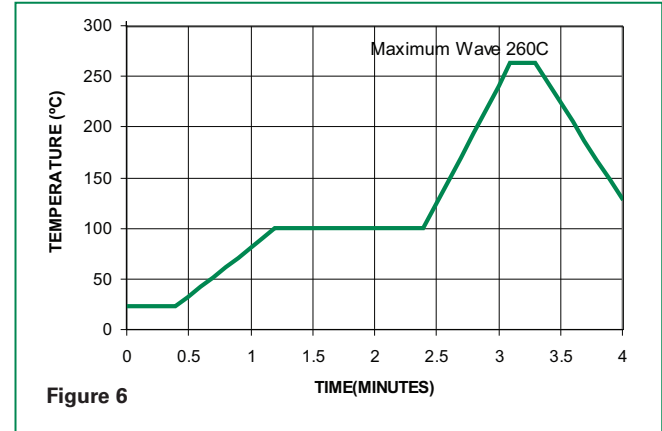

Physical Specifications

Lead Material	Tin-plated Copper
Soldering Characteristics	Solderability per MIL-STD-202, Method 208E
Insulating Material	Cured, flame retardant epoxy polymer meets UL94V-0 requirements.
Device Labeling	Marked with LF, part identifier, and date code

Environmental Specifications

Operating/Storage Temperature	-55°C to +85°C/ -55°C to +125°C
Humidity Aging	+85°C, 85% RH, 1000 hours +/-10% voltage
Thermal Shock	+85°C to -40°C 5 times +/-10% voltage
Solvent Resistance	MIL-STD-202, Method 215F
Moisture Sensitivity	Level 1, J-STD-020C

Part Numbering System

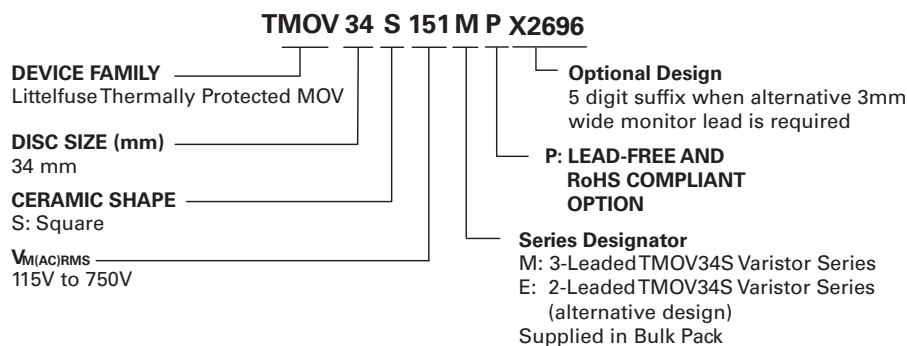

Dimensions 3 Leaded Series

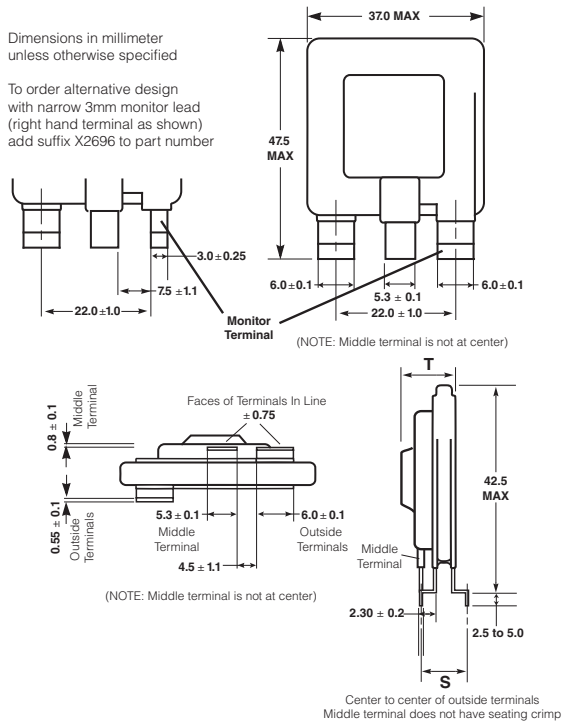

Part Number	"T" Max Body Thickness	"S" Mounting Terminal Offset
TMOV34S111M(P)	11.90	5.2 -/+ .65
TMOV34S131M(P)	12.20	5.5 -/+ .65
TMOV34S141M(P)	12.30	5.7 -/+ 0.85
TMOV34S151M(P)	12.40	5.9 -/+ 0.85
TMOV34S181M(P)	12.80	6.3 -/+ 0.85
TMOV34S201M(P)	13.00	6.5 -/+ 0.85
TMOV34S251M(P)	12.75	6.25 -/+ 0.85
TMOV34S271M(P)	12.95	6.5 -/+ 0.85
TMOV34S301M(P)	13.30	6.8 -/+ 1.0
TMOV34S321M(P)	13.50	6.9 -/+ 1.0
TMOV34S331M(P)	13.60	7.2 -/+ 1.0
TMOV34S351M(P)	13.80	7.4 -/+ 1.0
TMOV34S391M(P)	14.20	7.6 -/+ 1.0
TMOV34S421M(P)	14.50	7.85 -/+ 1.0
TMOV34S461M(P)	14.75	8.15 -/+ 1.0
TMOV34S481M(P)	14.95	8.25 -/+ 1.0
TMOV34S511M(P)	15.40	8.6 -/+ 1.0
TMOV34S551M(P)	15.60	8.65 -/+ 1.0
TMOV34S571M(P)	15.90	8.85 -/+ 1.0
TMOV34S621M(P)	16.40	9.25 -/+ 1.0
TMOV34S661M(P)	16.85	9.65 -/+ 1.0
TMOV34S681M(P)	17.20	9.85 -/+ 1.0
TMOV34S751M(P)	17.80	10.65 -/+ 1.0

Dimensions - Alternative 2 Leaded Series

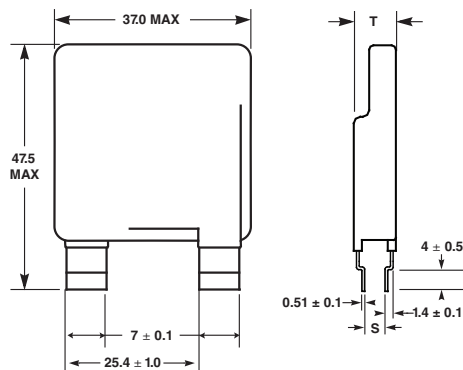

Part Number	T Dimension Max Body Thickness	S Dimension -- Mounting Terminal Offset
TMOV34S111EP	11.9	2.8 -/+ .65
TMOV34S131EP	12.2	2.9 -/+ .65
TMOV34S141EP	12.3	3.0 -/+ 0.85
TMOV34S151EP	12.4	3.1 -/+ 0.85
TMOV34S181EP	12.8	3.4 -/+ 0.85
TMOV34S201EP	13.0	3.6 -/+ 0.85
TMOV34S251EP	12.8	4.0 -/+ 0.85
TMOV34S271EP	13.0	4.3 -/+ 0.85
TMOV34S301EP	13.3	4.5 -/+ 1.0
TMOV34S321EP	13.5	4.7 -/+ 1.0
TMOV34S331EP	13.6	4.8 -/+ 1.0
TMOV34S351EP	13.8	5.0 -/+ 1.0
TMOV34S391EP	14.2	5.4 -/+ 1.0
TMOV34S421EP	14.5	5.7 -/+ 1.0
TMOV34S461EP	14.8	5.9 -/+ 1.0
TMOV34S481EP	15.0	6.1 -/+ 1.0
TMOV34S511EP	15.4	6.6 -/+ 1.0
TMOV34S551EP	15.6	6.8 -/+ 1.0
TMOV34S571EP	15.9	7.1 -/+ 1.0
TMOV34S621EP	16.4	7.5 -/+ 1.0
TMOV34S661EP	16.9	7.9 -/+ 1.0
TMOV34S681EP	17.2	8.2 -/+ 1.0
TMOV34S751EP	17.8	8.8 -/+ 1.0